

BERKELEY MAXUM U-DS24 ASSEMBLY

ITEM#	PARTS LIST	QTY
97-DS240A	Stand Frame	1
97-DS240B	Metal Guide	2
97-DS240C	Plastic Knob	4
97-DS240D	Hex Bolt	4
97-DS240E	Phillips Screw	14

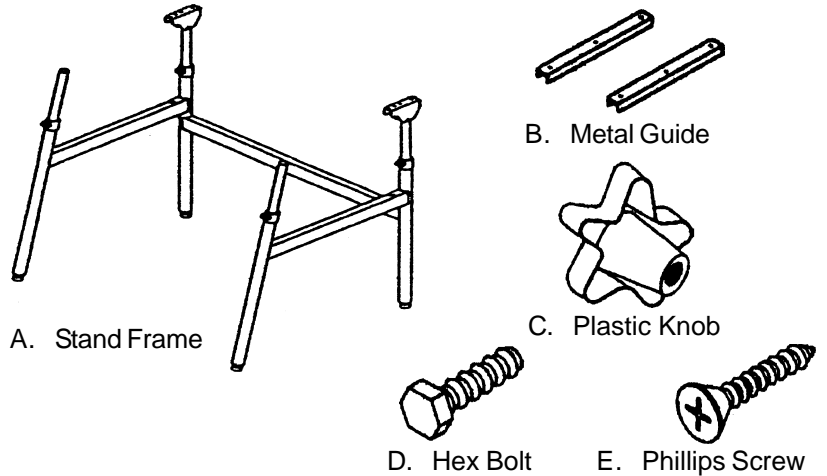

Your new Berkeley MAXUM Table has been designed and manufactured to enhance your productivity and efficiency. This sturdy **folding** table, properly assembled, will last through years of use. Follow the instructions below to assemble your Berkeley Maxum and refer to the enclosed parts list for part identification. Tools needed for assembly: screwdriver, hammer, nail or awl, tape measure and pencil. **NOTE: Attaching Top instructions on reverse side of this sheet.**

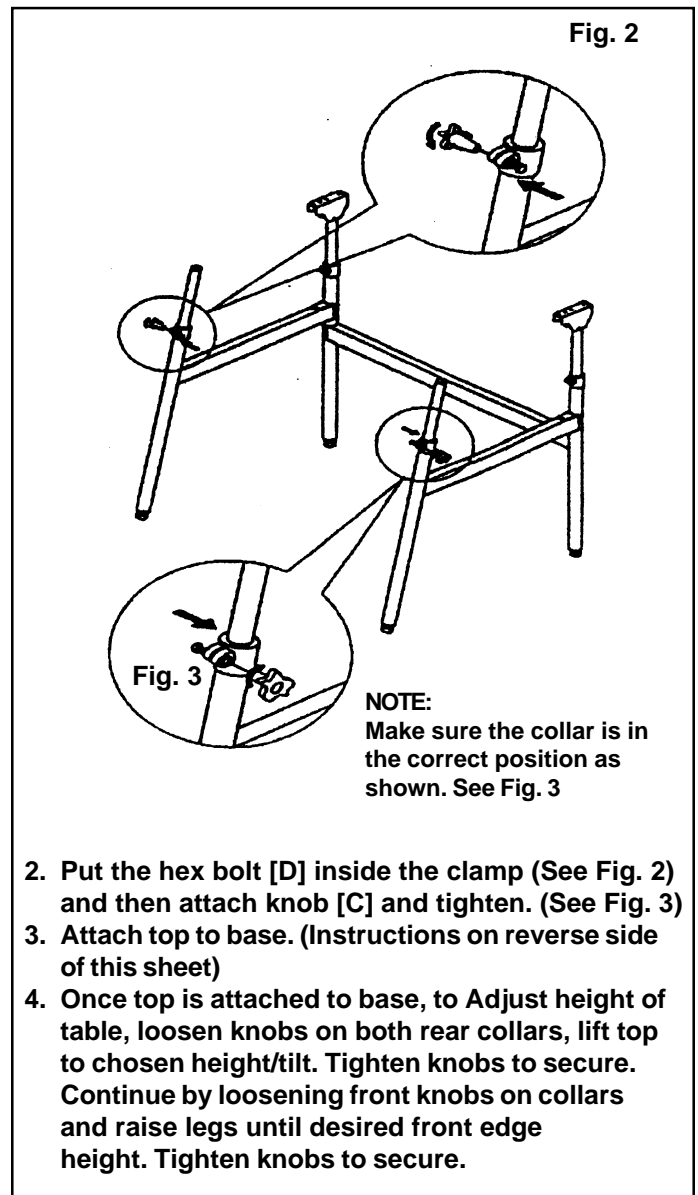
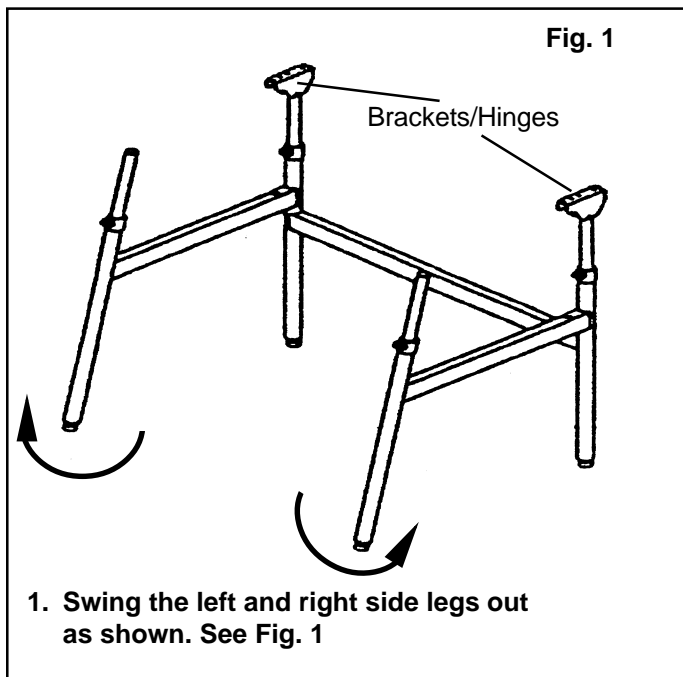

Any Questions with Assembly? We Can Help



PLEASE DO NOT RETURN THIS TABLE to the Store where you purchased it. If you are unable to assemble or parts are missing, PLEASE Call Customer Service at Martin Universal Design, Inc. 313-895-0700 or Email: custservmud@aol.com

ONE YEAR GUARANTEE

This Martin Universal Design, Inc. product has a one year guarantee to be free from manufacturers defects during that period of use by the original purchaser. Items or parts subjected to extreme temperature or abuse or use of this product other than manufacturers intended purpose is not covered under this guarantee.

MARTIN
Universal Design, Inc.

Martin Universal Design, Inc. • 4444 Lawton Avenue, Detroit, MI 48208 USA
Tel: (313)895-0700 / Fax:(313)895-0709 • E-mail: Custservmud@aol.com

BERKELEY MAXUM TOP ASSEMBLY

Determine which size top you have and follow the appropriate instructions

Instructions for 36" x 48" Top

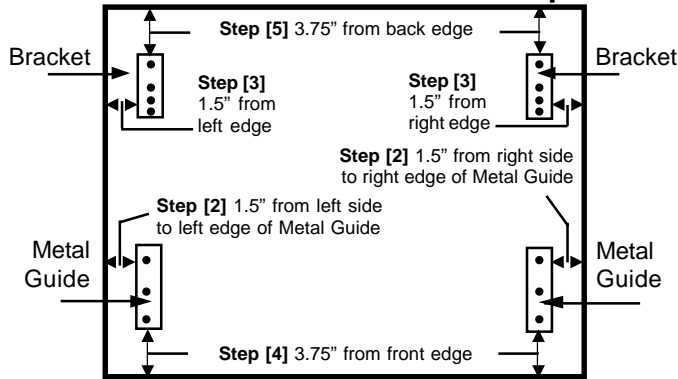

- Step 1. Place top onto carpeted floor.
- Step 2. Attach Left and Right Metal Guides by: Measuring 1.5" in from left edge and mark with pencil, repeat with right side. See above illustration.
- Step 3. Attaching Left and Right Brackets (already attached to base) by: Measuring 1.5" in from left edge and mark with pencil, repeat with right side. See above illustration.
- Step 4. Measure 3.75" from front edge and make pencil mark. Repeat with other side for Metal Guides.
- Step 5. Measure 3.75" from rear edge and make pencil mark. Repeat with other side for Brackets.
- Step 6. Position left and right Metal guides per above specs and Attach with [3] phillips screws per guide.
Please Note: You may have to break top surface by tapping a nail or awl in screw holes to make starting hole in surface before attaching screws.
- Step 7. Position left and right brackets per above specs and Attach with [4] phillips screws per bracket.
Please Note: You may have to break top surface by tapping a nail or awl in screw holes to make starting hole in surface before attaching screws

Instructions for 31.5" x 55" Top

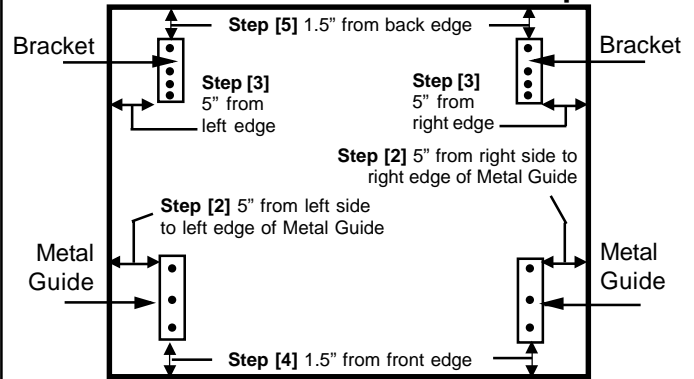

- Step 1. Place top onto carpeted floor.
- Step 2. Attach Left and Right Metal Guides by: Measuring 1.5" in from left edge and mark with pencil, repeat with right side. See above illustration.
- Step 3. Attaching Left and Right Brackets (already attached to base) by: Measuring 1.5" in from left edge and mark with pencil, repeat with right side. See above illustration.
- Step 4. Measure 5" from front edge and make pencil mark. Repeat with other side for Metal Guides.
- Step 5. Measure 5" from rear edge and make pencil mark. Repeat with other side for Brackets.
- Step 6. Position left and right Metal guides per above specs and Attach with [3] phillips screws per guide.
Please Note: You may have to break top surface by tapping a nail or awl in screw holes to make starting hole in surface before attaching screws.
- Step 7. Position left and right brackets per above specs and Attach with [4] phillips screws per bracket.
Please Note: You may have to break top surface by tapping a nail or awl in screw holes to make starting hole in surface before attaching screws

Instructions for 37.5" x 48" Top

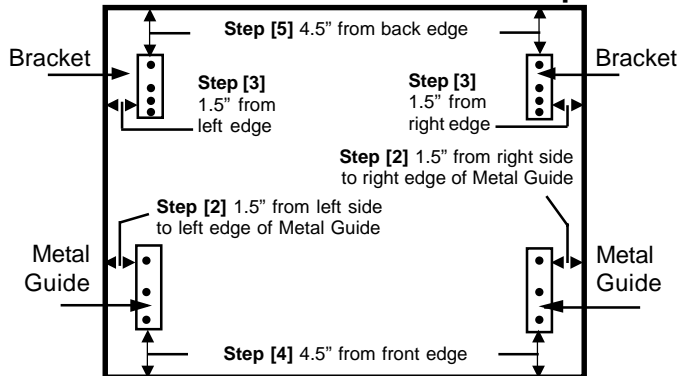

- Step 1. Place top onto carpeted floor.
- Step 2. Attach Left and Right Metal Guides by: Measuring 1.5" in from left edge and mark with pencil, repeat with right side. See above illustration.
- Step 3. Attaching Left and Right Brackets (already attached to base) by: Measuring 1.5" in from left edge and mark with pencil, repeat with right side. See above illustration.
- Step 4. Measure 4.5" from front edge and make pencil mark. Repeat with other side for Metal Guides.
- Step 5. Measure 4.5" from rear edge and make pencil mark. Repeat with other side for Brackets.
- Step 6. Position left and right Metal guides per above specs and Attach with [3] phillips screws per guide.
Please Note: You may have to break top surface by tapping a nail or awl in screw holes to make starting hole in surface before attaching screws.
- Step 7. Position left and right brackets per above specs and Attach with [4] phillips screws per bracket.
Please Note: You may have to break top surface by tapping a nail or awl in screw holes to make starting hole in surface before attaching screws

Instructions for 37.5" x 60" Top

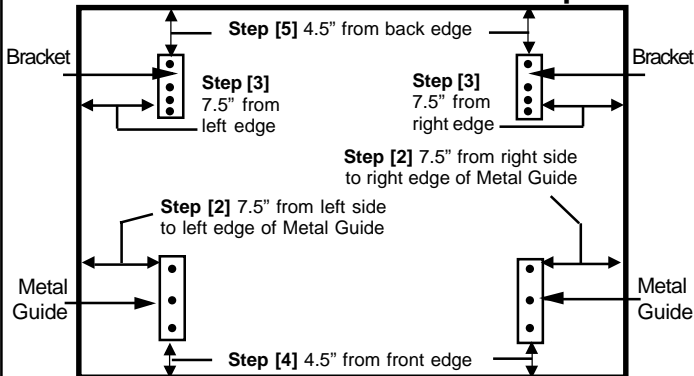

- Step 1. Place top onto carpeted floor.
- Step 2. Attach Left and Right Metal Guides by: Measuring 1.5" in from left edge and mark with pencil, repeat with right side. See above illustration.
- Step 3. Attaching Left and Right Brackets (already attached to base) by: Measuring 1.5" in from left edge and mark with pencil, repeat with right side. See above illustration.
- Step 4. Measure 3.75" from front edge and make pencil mark. Repeat with other side for Metal Guides.
- Step 5. Measure 3.75" from rear edge and make pencil mark. Repeat with other side for Brackets.
- Step 6. Position left and right Metal guides per above specs and Attach with [3] phillips screws per guide.
Please Note: You may have to break top surface by tapping a nail or awl in screw holes to make starting hole in surface before attaching screws.
- Step 7. Position left and right brackets per above specs and Attach with [4] phillips screws per bracket.
Please Note: You may have to break top surface by tapping a nail or awl in screw holes to make starting hole in surface before attaching screws