

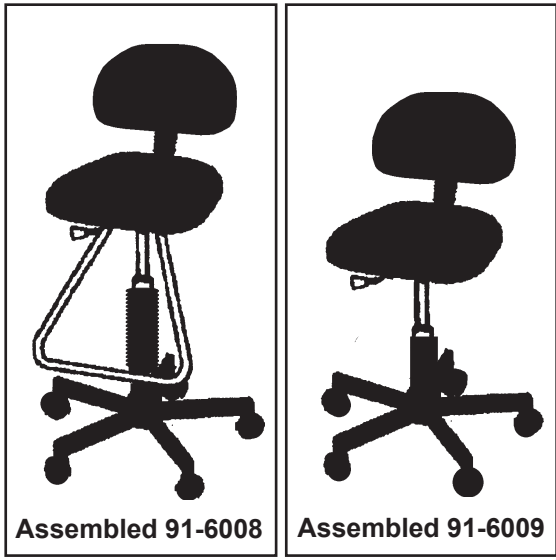

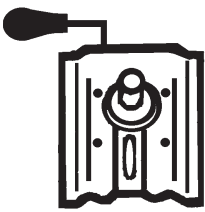

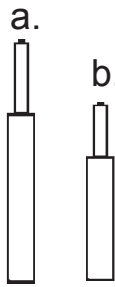

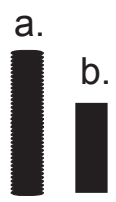



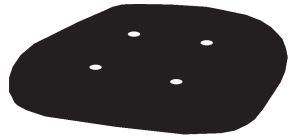

IMPORTANT NOTICE
YOU WILL FEEL A SLIGHT
“BOUNCE-BACK” WHEN YOU SIT DOWN.
THIS IS NORMAL: NOT A DEFECT.
THE PNEUMATIC CYLINDER FOR THE SEAT
HEIGHT ADJUSTMENT REACTS TO YOUR
WEIGHT BY GIVING A LITTLE

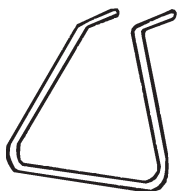
Model
91-6008 & 91-6009



Parts

-  A. [1] Base Plate & Lever
-  B. [1] Cylinder
 [a] bellows 91-6008 model
 [b] bellows 91-6009 model
-  C. [1] Bellows
 [a] bellows 91-6008 model
 [b] bellows 91-6009 model
-  D. [1] Backrest Support Bar
 Note: Part [K] is attached to part [D]
-  E. [1] 5-Star Base
-  F. [5] Push-in Castors
-  G. [1] Backrest
-  H. [1] Seat
 Note: Part [N] 4 screws are attached to part [H]
-  I. [1] Backrest Cover
-  J. [1] Footrest
 Model 91-6008 only.
-  K. [1] Knob
 Note: This knob is attached to Part [D]
-  L. [4] Nuts
-  M. [4] Bolts
 Model 91-6008 only.
-  N. [4] 3/4" Black Screws
 Note: These screws are attached to Part [H]
-  O. [2] 1" Black Screws
-  P. [1] Metal Backrest Plate

MARTIN
 Universal Design, Inc.
 4444 Lawton Avenue, Detroit MI 48208 USA
 Tel:(313)895-0700 • Fax:(313)895-0709
 E-mail: Custservmud@aol.com
 Visit us at:
www.MartinUniversalDesign.com

IMPORTANT
 If you have difficulty assembling your chair or need customer service assistance. Please call: Martin Universal Design, Inc. Customer Service Hot Line at 1-800-366-7337. If you need additional parts, it is not necessary to contact your dealer, our Customer Service Rep. will forward them to you immediately.

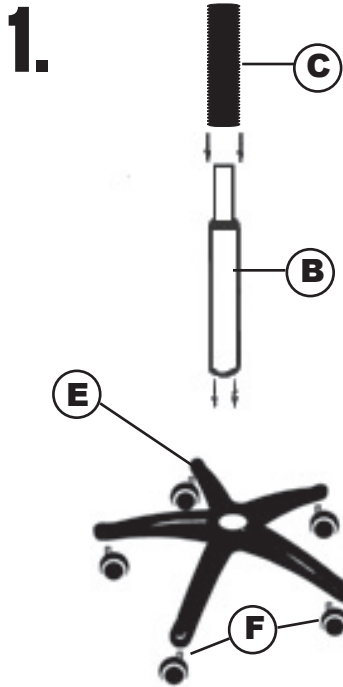

Place base (E) face down and push castors (F) in firmly. Insert cylinder (B) through base cap into chair base. Twist and press firmly. Slide Bellows (C) down over cylinder.

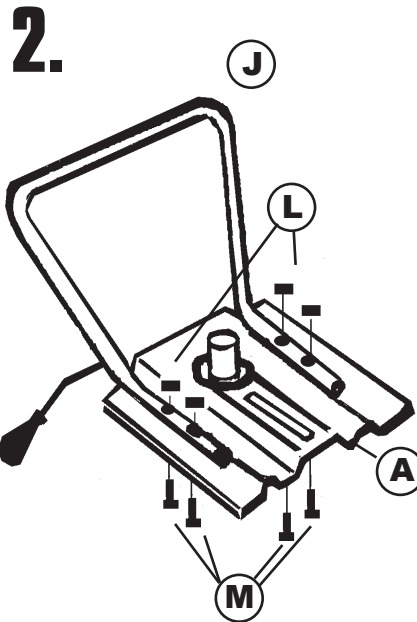

THIS STEP IS ONLY FOR MODEL 91-6008

Attach foot bar (J) to base plate (A) using [4] Silver Bolts (M) and [4] nuts (L). Line up holes in footbar to holes in seat plate. Tighten securely.

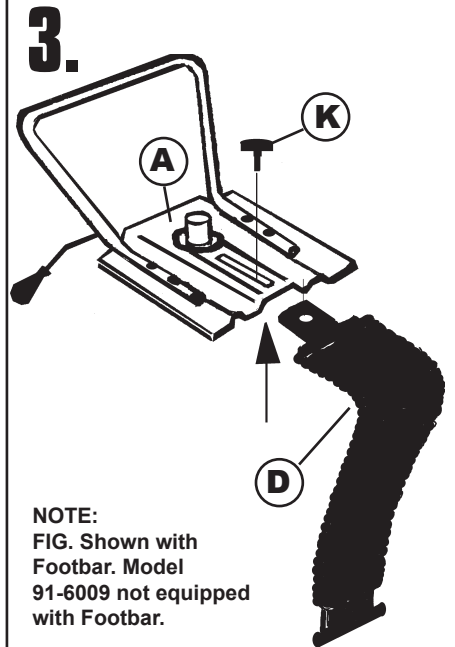

NOTE:
FIG. Shown with Footbar. Model 91-6009 not equipped with Footbar.

Attach support bar with bellows (D) to seat plate (A) by sliding the bar into the raised area of the seat plate (see arrow for location). Thread Knob (K) into hole in seat plate, making sure knob threads through seat plate.

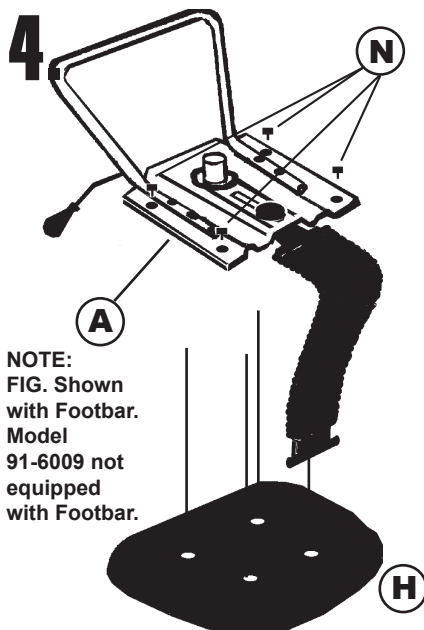

NOTE:
FIG. Shown with Footbar. Model 91-6009 not equipped with Footbar.

With seat cushion lying plastic side up, line up [4] holes in seat plate (A) with [4] holes in seat cushion (H). Attach with [4] 3/4" black screws (N). Tighten securely. Please Note: Foot bar should face front of seat cushion (Front of cushion has label attached.)

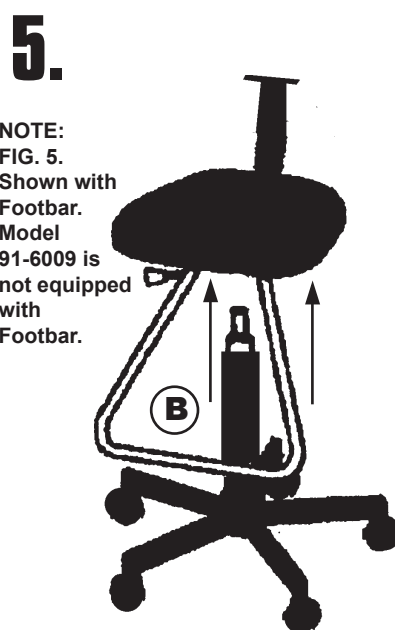

NOTE:
FIG. 5. Shown with Footbar. Model 91-6009 is not equipped with Footbar.

Take the complete seat assembly and insert the seat plate over the cylinder (B) by inserting the cylinder into the hole on the bottom of the seat plate (A).

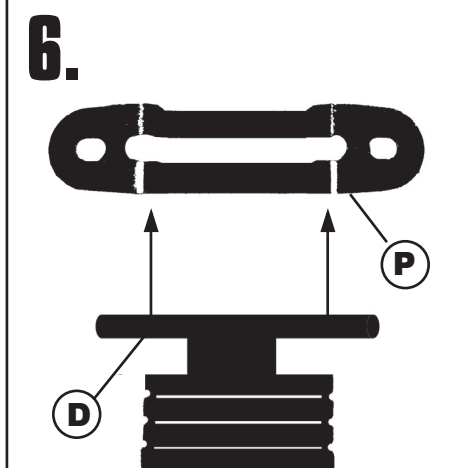

Attach backrest plate (P) to backrest support bar (D) by inserting backrest support bar "T" into longated slot in backrest plate (P). Continue with Step 7.

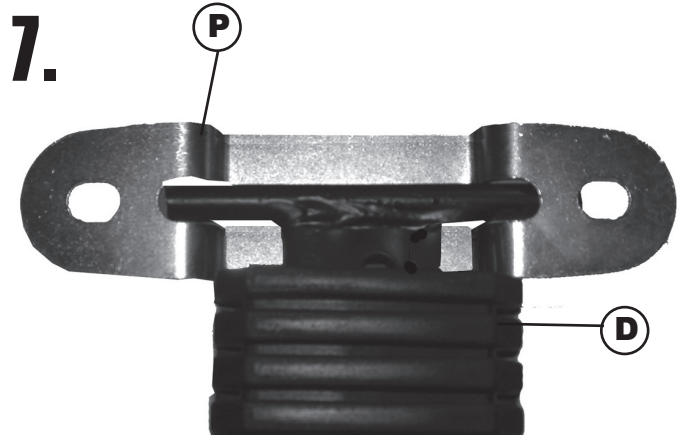

If properly assembled, the backrest plate (P) and backrest support bar (D) should look like the above photograph. Once this is achieved move on to Step 8.

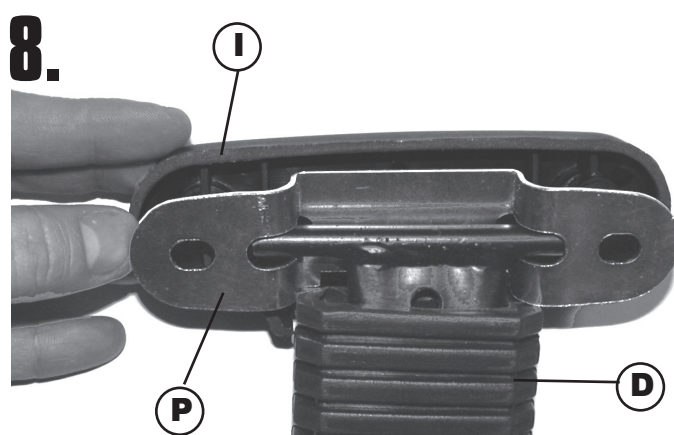

Continue by taking the Backrest Cover (I) and placing it into position onto the backside of the backrest plate (P). NOTE: The metal backrest plate should lay flat against the backrest cover (I).



The Backrest Support bar should now look like the above photograph. This Backrest Support Bar is now ready to have the backrest (G) attached to it. NOTE: Backrest Support should be attached to seat as displayed in Step 4.

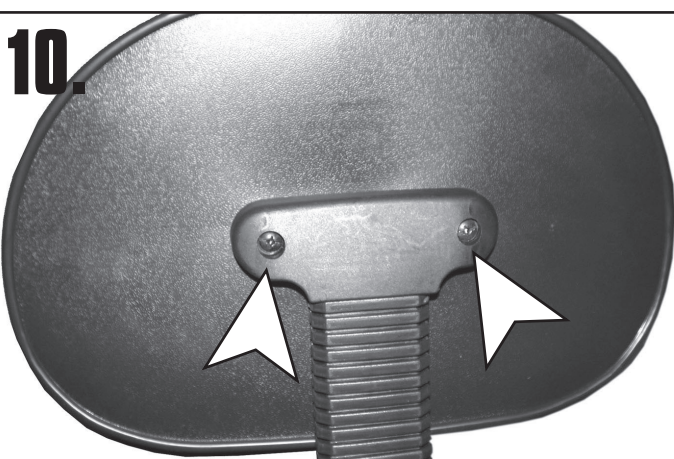

Attach Backrest Support assembly (Parts D, I & P) to upholstered back using the [2] black screws provided making sure the screw holes in backrest cover (I) line up with the screw holes in the upholstered back. Tighten screws securely.



IMPORTANT

If you have difficulty assembling your chair or need customer service assistance. Please call: Martin Universal Design, Inc. Customer Service Hot Line at 1-800-366-7337. If you need additional parts, it is not necessary to contact your dealer, our Customer Service Rep. will forward them to you immediately.

MARTIN
Universal Design, Inc.

4444 Lawton Avenue, Detroit MI 48208 USA Tel:(313)895-0700 •
Fax:(313)895-0709
E-mail: Custservmud@aol.com
Visit us at:
www.MartinUniversalDesign.com